

ROOF-HP

F 400 (400°C/120')
F 600 (600°C/120')

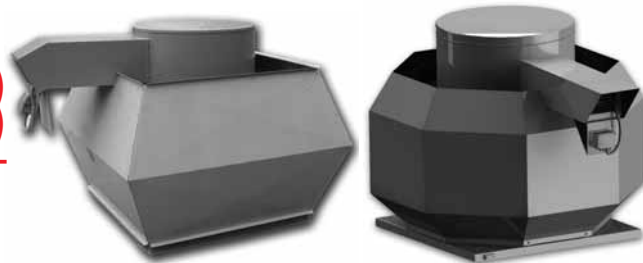

ROOF-HP F600

ROOF-HP F400

Torrino centrifugo a flusso verticale per fumi d'incendio secondo EN 12101-3
Smoke exhaust vertical discharge centrifugal roof fan according to EN 12101-3

APPLICAZIONI

I torrini a flusso verticale della serie ROOF-HP sono impiegati negli impianti dove è necessaria l'estrazione dei fumi d'incendio in ambienti quali parcheggi interrati, centri commerciali ospedali, scuole, teatri, musei, ecc. La serie ROOF-HP è progettata e costruita in ottemperanza alla direttiva Europea EN 12101-3 ottenendo la certificazione da un Ente Autonomo Qualificato. I torrini ROOF-HP sono idonei al funzionamento per il convogliamento d'aria pulita e fumi non polverosi, fino alla temperatura massima di 200 C° in servizio continuo o in caso di emergenza alla temperatura di 400°C per 120 minuti (F400) o 600°C per 120 minuti (F600).

GAMMA

La gamma è composta da 9 grandezze con diametro girante da 400 a 1000 mm.

PECULIARITA'

I torrini di questa serie sono caratterizzati da una costruzione molto più robusta rispetto a quelli comunemente presenti sul mercato e quindi sono particolarmente adatti ad impieghi gravosi. La girante saldata a pale rovesce ed il motore termo-isolato con ventilazione esterna permettono l'effettivo funzionamento con temperature fino a 200°C in servizio continuo. Possono inoltre raggiungere altissime prestazioni, si arriva infatti fino ad una portata di 52.000 mc/h ed a prevalenze di 1300Pa.

COSTRUZIONE

- Convogliatore esterno realizzato in alluminio, piastra di supporto con boccaglio in lamiera di acciaio. Verniciatura protettiva RAL 7040.
- Girante a pale rovesce saldata realizzata in acciaio progettata per garantire il massimo rendimento e un basso livello di rumore. Equilibrata secondo UNI EN-ISO 1940-1 grado G 6.3.
- Motore direttamente accoppiato isolato dal flusso d'aria, raffreddato dall'aria esterna.
- Motore asincrono trifase, grado di protezione IP 55, isolamento classe F, singola o doppia polarità, idoneo a servizio S1, forma B5, costruzione a norme IEC/EEC (UNEL MEC), fornito con PTC.
- Morsettiera esterna per agevolare le operazioni di cablaggio.

SPECIFICHE TECNICHE

- Aria convogliata : max 200°C in servizio S1.
F600 max 600°C in servizio S2
F400 max 400°C in servizio S2
(emergenza incendio)
- Tensione e frequenza d'alimentazione:
- Versione trifase (T) 400V-50 Hz

A RICHIESTA

- Versione con motore a doppia polarità.

ACCESSORI

- Serranda a gravità in aspirazione (GS-RH)
- Giunto antivibrante in aspirazione (FC-RH)
- Rete di protezione in aspirazione (RA-RH)
(Necessaria nell'utilizzo a bocca libera)
- Silenziatore in aspirazione (SIL-RH)

APPLICATIONS

The vertical discharge roof fan line ROOF-HP are destined to the plants requiring the evacuation of fire smokes, in environments like underground car parks, shopping malls, hospitals, schools, theatres, museums, etc. This series is designed and manufactured according to the European directive EN 12101-3 certified by an Autonomous Qualified Certification Institute. ROOF-HP fans are suitable to convey clean air and non dusty smokes up to the maximum temperature of 200°C in continuous service and in case of fire emergency at the temperature of 400°C for 120 minutes (F400) or 600°C for 120 minutes (F600).

RANGE

This line consists of 9 sizes with impeller diameter from 400 up to 1000 mm.

ADVANTAGES

The roof fans of this series are characterized by a construction much more robust than the others commonly present in the market and they are therefore particularly suitable for heavy duty applications. The backward curved welded impeller and the thermo-isolated motor with external ventilation allow the real operation in continuous service up to 200°C. They can also get very high performance, up to 52.000 mc/h and 1300Pa.

CONSTRUCTION

- External conveyor in aluminum, support plate with inlet cone in steel sheet. Protection coating RAL 7040.
- Backward curved blade impeller, in steel sheet, designed to guarantee the maximum efficiency and low noise level. Balanced according to UNI EN-ISO 1940-1 degree G 6.3.
- Directly coupled motor, outside the airflow, cooled by the external air.
- Asynchronous three-phase motor, protection IP 55, insulation class F, single or double polarity, suitable for S1 service, mounting type B5, according to IEC/EEC (UNEL MEC), supplied with PTC.
- External terminal box for easy wiring.

TECHNICAL SPECIFICATIONS:

- Conveyed air : max 200°C in S1 service.
F600 max 600°C in S2 service.
F400 max 400°C in S2 service.
(fire emergency)
- Voltage and frequency :
- Three-phase version (T) 400V-50 Hz

ON REQUEST

- Version with double polarity motor.

ACCESSORIES

- Inlet Gravity shutter (GS-RH)
- Inlet Flexible joint (FC-RH)
- Inlet Protection grid RA-RH)
(Necessary for use in free air)
- Inlet Silencer (SIL-RH)

1 mm H₂O = 9,8 Pa

Performance shown in the selection diagrams refer to air at 15°C temperature and 0 mt a.s.l. altitude, and they were obtained in installation type "C" with no grid nor accessories.

ROOF-HP F400

4 poli/poles (1500 rpm) - trifase/three-phase (3Ph-400V 50Hz)

Modello Model	Portata - Flow rate (m ³ /h)	Pm (kW)	In max (A)	Mot. (H)	Lp dB(A)
404 T	4.700	0,55	1,48	80	63
454 T	6.700	1,1	2,7	90	68
504 T	9.100	1,5	3,5	90	71
564 T	13.300	3	6,4	100	74
634 T	19.300	5,5	10,8	132	78
714/A T	23.200	7,5	14,3	132	81
714/B T	27.500	11	20,9	160	82
804/A T	36.400	15	28,1	160	84
804/B T	39.500	18,5	33,3	180	85

6 poli/poles (1000 rpm) - trifase/three-phase (3Ph-400V 50Hz)

Modello Model	Portata - Flow rate (m ³ /h)	Pm (kW)	In max (A)	Mot. (H)	Lp dB(A)
406 T	3.100	0,37	1,17	80	54
456 T	4.500	0,55	1,72	80	59
506 T	6.100	0,55	1,72	80	61
566 T	8.700	1,5	4	100	65
636 T	12.400	2,2	5,12	112	69
716/A T	15.500	3	7	132	71
716/B T	18.300	4	8,90	132	73
806/B T	26.000	5,5	12	132	76
906 T	37.000	11	22,4	160	80
1006/A T	43.100	15	29,4	180	81
1006/B T	52.000	18,5	35,3	200	83

8 poli/poles (700 rpm) - trifase/three-phase (3Ph-400V 50Hz)

Modello Model	Portata - Flow rate (m ³ /h)	Pm (kW)	In max (A)	Mot. (H)	Lp dB(A)
908 T	27.500	5,5	12,4	160	74
1008 T	38.000	7,5	16,3	160	75

4/6 poli/poles (1500/1000 rpm) - trifase/three-phase (3Ph-400V 50Hz)

Modello Model	Portata - Flow rate (m ³ /h)	Pm (kW)	In max (A)	Mot. (H)	Lp dB(A)
404-6 T	4.700/3.100	0,6/0,20	1,69/1,02	80	63/54
454-6 T	6.700/4.500	1/0,35	3,13/1,36	90	68/59
504-6 T	9.100/6.100	1,5/0,4	4,63/1,46	90	71/61
564-6 T	13.300/8.700	3/1	7,8/2,88	112	74/65
634-6 T	19.300/12.400	6/2,2	11,8/5,66	132	78/69
714-6/A T	23.200/15.500	10/3,3	21,1/8,4	160	81/71
714-6/B T	27.500/18.300	13/4,4	25,3/10,8	160	82/73
804-6/A T	36.400/24.500	16/5,4	30,5/13,9	180	84/76

4/8 poli/poles (1500/700 rpm) - trifase/three-phase (3Ph-400V 50Hz)

Modello Model	Portata - Flow rate (m ³ /h)	Pm (kW)	In max (A)	Mot. (H)	Lp dB(A)
404-8 T	4.700/2.400	0,6/0,12	1,72/0,75	80	63/48
454-8 T	6.700/3.300	1,4/0,3	3,63/1,21	90	68/54
504-8 T	9.100/4.400	1,8/0,4	4,44/1,43	90	71/56
564-8 T	13.300/6.500	2,8/0,7	6,3/2,42	100	74/59
634-8 T	19.300/9.600	6,5/1,8	13,9/5,62	132	78/63
714-8/A T	23.200/11.600	10/2,5	20,2/6,6	160	81/66
714-8/B T	27.500/13.800	12,5/3,5	23,4/8,3	160	82/67
804-8/A T	36.400/13.800	16/4,5	29,9/11	180	84/69

ROOF-HP F600

4 poli/poles (1500 rpm) - trifase/three-phase (3Ph-400V 50Hz)

Modello Model	Portata - Flow rate (m ³ /h)	Pm (kW)	In max (A)	Mot. (H)	Lp dB(A)
404 T	4.700	0,55	1,48	80	63
454 T	6.700	1,1	2,7	90	68
504 T	9.100	1,5	3,5	90	71
564 T	13.300	3	6,4	100	74
634 T	19.300	5,5	10,8	132	78
714/B T	27.500	9	17,9	132	82
804/B T	39.500	15	28,1	160	85

6 poli/poles (1000 rpm) - trifase/three-phase (3Ph-400V 50Hz)

Modello Model	Portata - Flow rate (m ³ /h)	Pm (kW)	In max (A)	Mot. (H)	Lp dB(A)
406 T	3.100	0,37	1,17	80	55
456 T	4.500	0,75	2,19	90	59
506 T	6.100	0,75	2,19	90	62
566 T	8.700	1,5	4	100	65
636 T	12.900	3	7	132	68
716 T	18.300	3	7	132	72
806 T	26.000	5,5	12	132	75
906 T	37.000	11	22,4	160	80
1006/A T	41.000	11	22,4	160	82
1006/B T	52.000	15	29,4	180	83

8 poli/poles (700 rpm) - trifase/three-phase (3Ph-400V 50Hz)

Modello Model	Portata - Flow rate (m ³ /h)	Pm (kW)	In max (A)	Mot. (H)	Lp dB(A)
908 T	27.500	5,5	12,4	160	73
1008 T	38.000	7,5	16,3	160	77

4/6 poli/poles (1500/1000 rpm) - trifase/three-phase (3Ph-400V 50Hz)

Modello Model	Portata - Flow rate (m ³ /h)	Pm (kW)	In max (A)	Mot. (H)	Lp dB(A)
404-6 T	4.700/3.100	0,6/0,20	1,69/1,02	80	63/55
454-6 T	6.700/4.500	1/0,35	3,13/1,36	90	68/59
504-6 T	9.100/6.200	1,5/0,4	4,63/1,46	90	71/62
564-6 T	13.300/8.700	3/1	7,8/2,88	112	74/65
634-6 T	19.300/12.900	6/2,2	11,8/5,66	132	78/68
714-6/B T	27.500/18.300	10/3,3	21,1/8,4	160	82/72
804-6/A T	39.500/26.000	16/5,4	30,5/13,9	180	85/75

4/8 poli/poles (1500/700 rpm) - trifase/three-phase (3Ph-400V 50Hz)

Modello Model	Portata - Flow rate (m ³ /h)	Pm (kW)	In max (A)	Mot. (H)	Lp dB(A)
906-8 T	37.000/27.500	11/5	23/14	180	80/73

Attenzione: il livello di pressione sonora è riferito ad una misurazione onnidirezionale in campo libero a 4 m dal ventilatore con aspirazione e mandata canalizzate.

Attention: sound pressure level is measured in free field at 4 m from the fan, in any direction, with ducted inlet and outlet.

Le prestazioni indicate nei diagrammi si riferiscono ad aria alla temperatura di 15°C ed all' altitudine di 0 mt s.l.m. , e sono state ottenute in installazioni di tipo "C" in assenza di reti e accessori .
 Performance shown in the selection diagrams refer to air at 15°C temperature and 0 mt a.s.l. altitude, and they were obtained in installation type "C" with no grid nor accessories .

ROOF-HP 400 (F400 - F600)

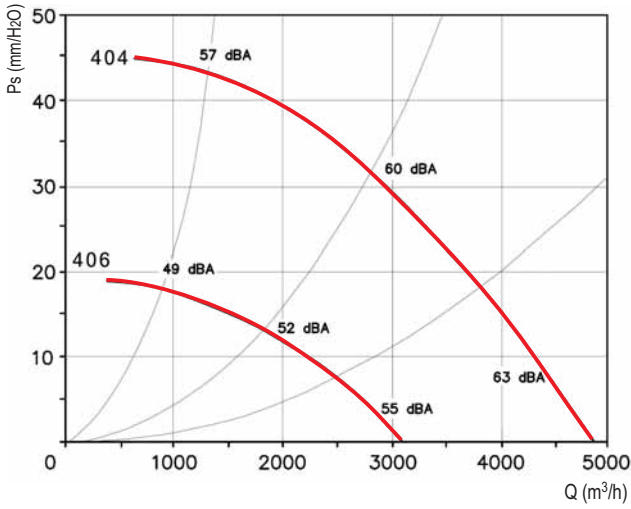

ROOF-HP 450 (F400 - F600)

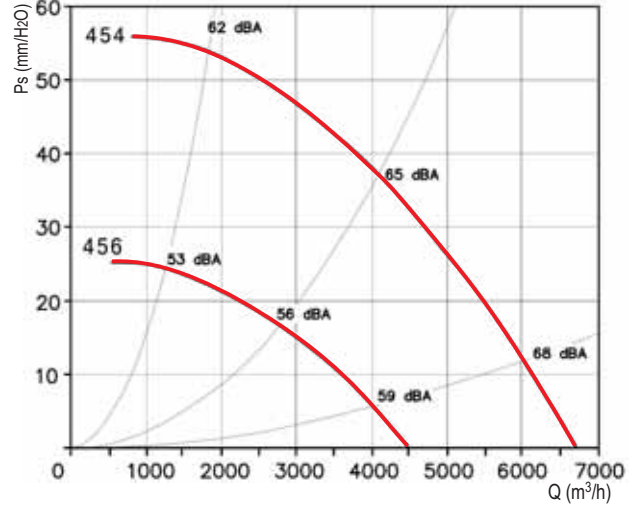

ROOF-HP 500 (F400 - F600)

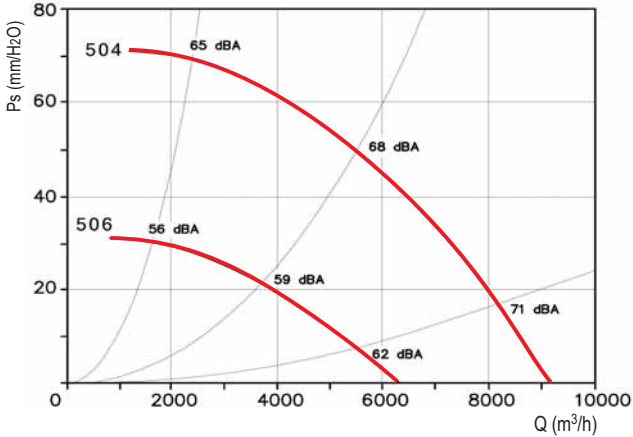

ROOF-HP 560 (F400 - F600)

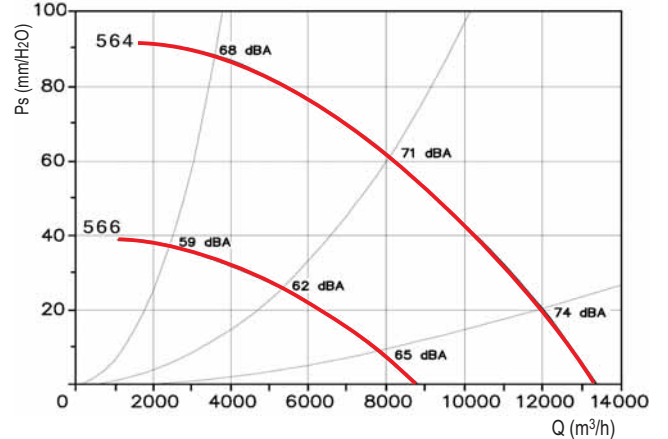

ROOF-HP 630 (F400 - F600)

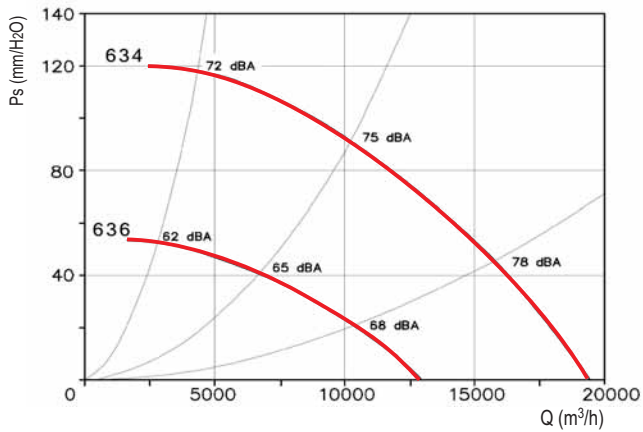

Le prestazioni indicate nei diagrammi si riferiscono ad aria alla temperatura di 15°C ed all'altitudine di 0 mt s.l.m., e sono state ottenute in installazioni di tipo "C" in assenza di reti e accessori.
 Performance shown in the selection diagrams refer to air at 15°C temperature and 0 mt a.s.l. altitude, and they were obtained in installation type "C" with no grid nor accessories.

ROOF-HP 710/A (F400)

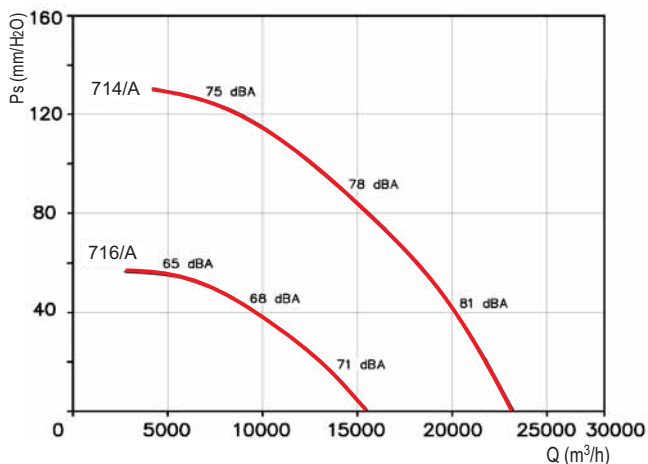

ROOF-HP 710/B (F400 - F600)

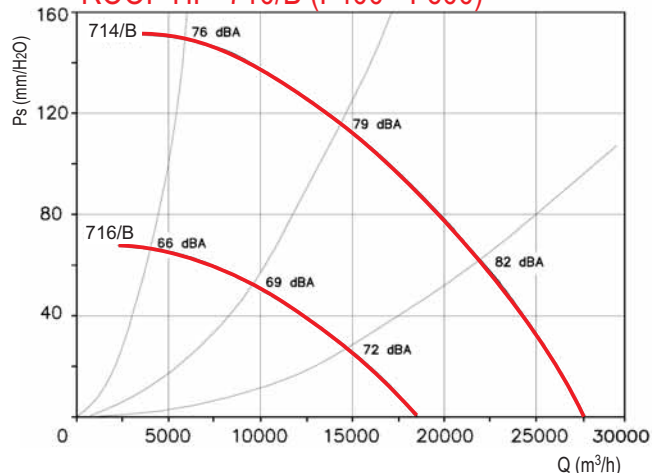

ROOF-HP 800/A (F400)

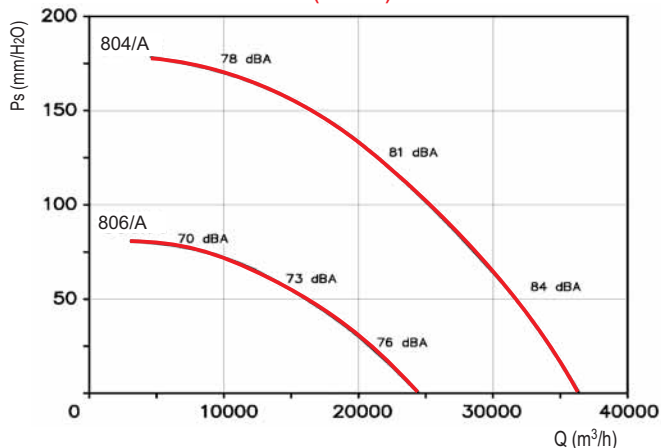

ROOF-HP 800/B (F400 - F600)

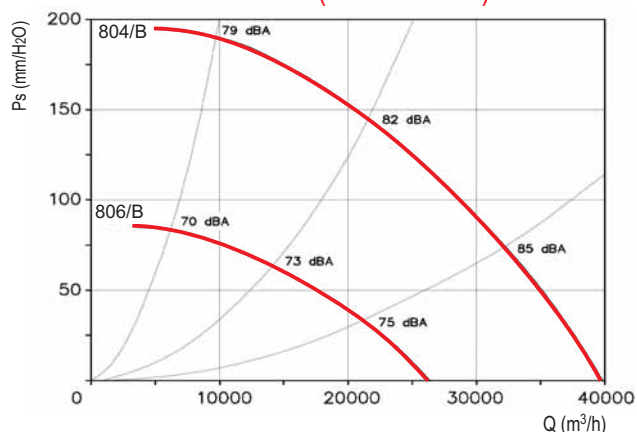

ROOF-HP 900 (F400 - F600)

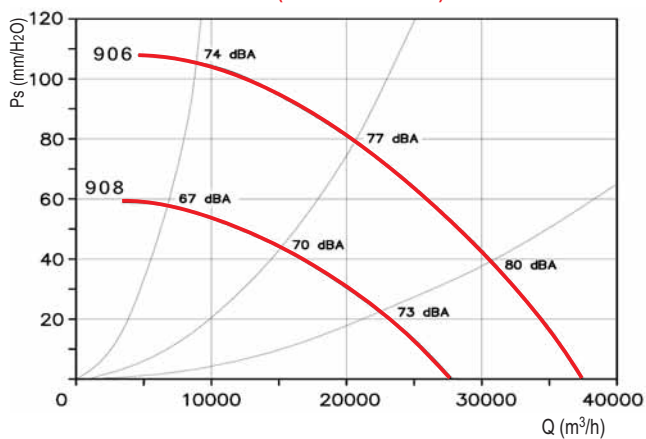

ROOF-HP 1000 (F400 - F600)

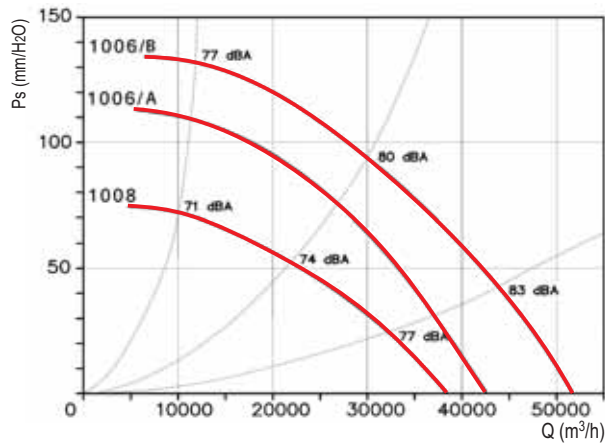

Attenzione: il livello di pressione sonora è riferito ad una misurazione onnidirezionale in campo libero a 4 m dal ventilatore con aspirazione canalizzata.
 Attention: sound pressure level is measured in free field at 4 m from the fan, in any direction, with ducted inlet.

ROOF-HP F400

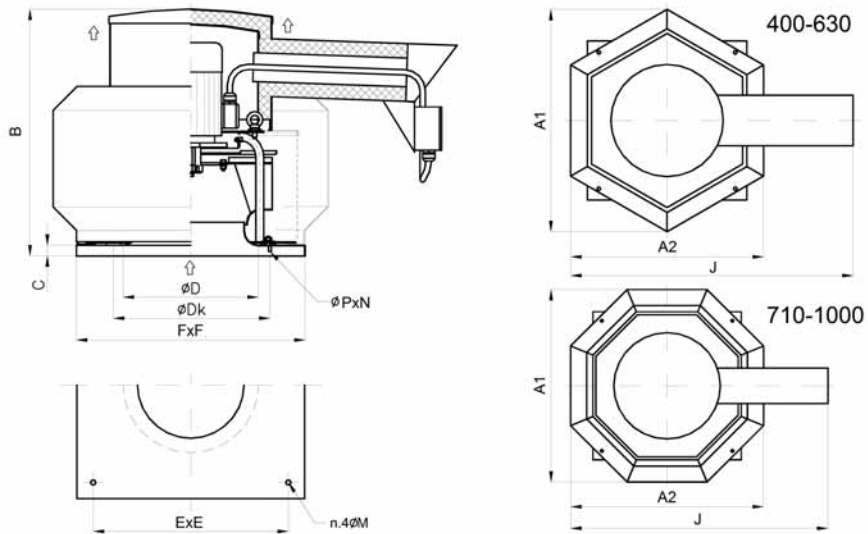

Model	A1	A2	J	B	C	ØD	ØD _k	E	F	ØM	n° P	ØN	kg
400	780	675	1009	615	30	315	356	480	560	12	8	M 8	48
450	880	762	1116	690	30	400	438	540	630	12	6	M 8	60-67
500	980	849	1232	740	40	450	487	610	710	14	6	M 8	83-92
560	1100	953	1361	830	40	500	541	700	800	14	6	M 8	116-128
630	1315	1140	1548	960	40	560	605	780	900	14	8	M 10	163-198
710	1300	1300	1735	1130	50	630	674	880	1000	18	8	M 10	242-305
800	1490	1490	2027	1270	50	710	751	1000	1120	18	8	M 10	390-435
900	1650	1650	2183	1305	50	800	837	1100	1250	22	12	M 10	390-415
1000	1850	1850	2437	1400	50	900	934	1250	1400	22	12	M 10	530-625

Dimensioni in mm/Dimensions in mm

ROOF-HP F600

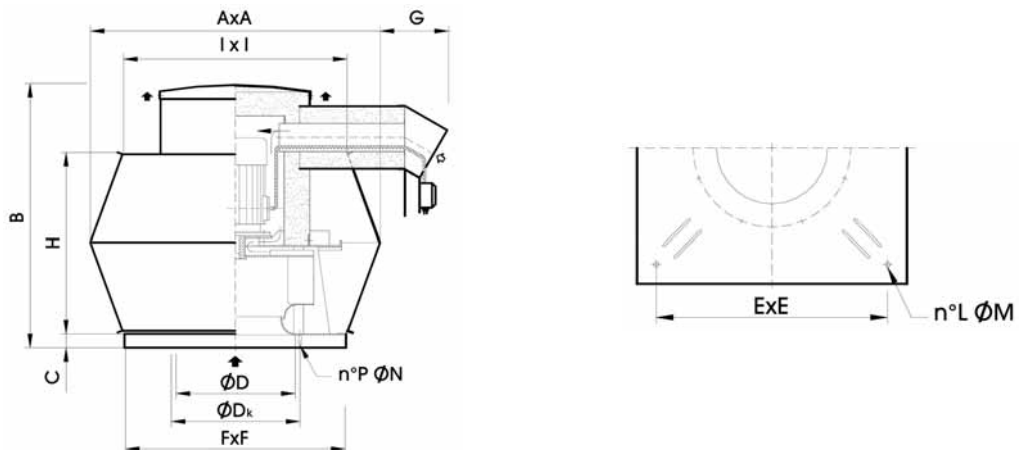

Model	A	B	C	ØD	ØD _k	E	F	G	H	I	n°L	ØM	n° P	ØN	kg
400	745	700	40	315	356	480	560	300	485	570	4	12	8	M8	80
450	832	750	40	400	438	540	630	320	525	642	4	12	6	M8	110
500	945	820	40	450	487	610	710	340	615	723	4	14	6	M8	130
560	1053	920	40	500	541	700	800	360	670	813	4	14	6	M8	170-180
630	1196	1080	40	560	605	780	900	390	785	915	4	14	8	M10	260-270
710	1322	1260	50	630	674	880	1000	390	845	1017	4	18	8	M10	355-390
800	1491	1350	50	710	751	1000	1120	450	980	1138	4	18	8	M10	480-580
900	1652	1400	50	800	837	1100	1250	470	1065	1268	4	22	12	M10	640-690
1000	1856	1510	50	900	934	1250	1400	490	1210	1420	4	22	12	M10	770-820

Dimensioni in mm/Dimensions in mm

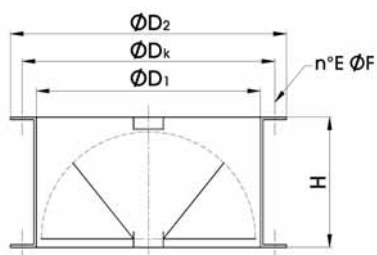

(GS-RH)
Serranda gravità/Gravity shutter

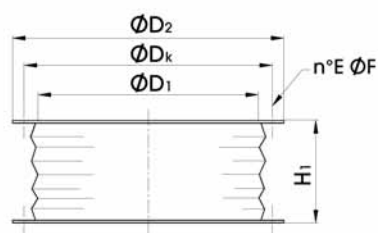

(FC-RH)
Giunto antivibrante/Flexible joint

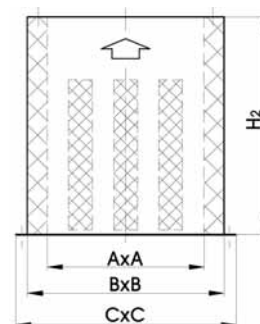

(SIL-RH)
Silenziatore/Silencer

Model	A	B	C	Ø D1	Ø D2	Ø Dk	H	H1	H2	n.E ØF
400	440	548	645	315	382	356	180	120	750	8x10
450	505	614	720	400	464	438	220	120	800	6x10
500	585	694	800	450	513	487	250	120	850	6x10
560	670	780	900	500	567	541	280	150	900	6x10
630	770	880	996	560	639	605	310	150	950	8x12
710	870	980	1134	630	708	674	350	150	1250	8x12
800	990	1100	1254	710	785	751	400	150	1300	8x12
900	1120	1230	1384	800	871	837	440	150	1350	12x12
1000	1270	1380	1534	900	968	934	500	150	1450	12x12

Dimensioni in mm/Dimensions in mm

ROOF-HP | Parti di ricambio
Spare parts

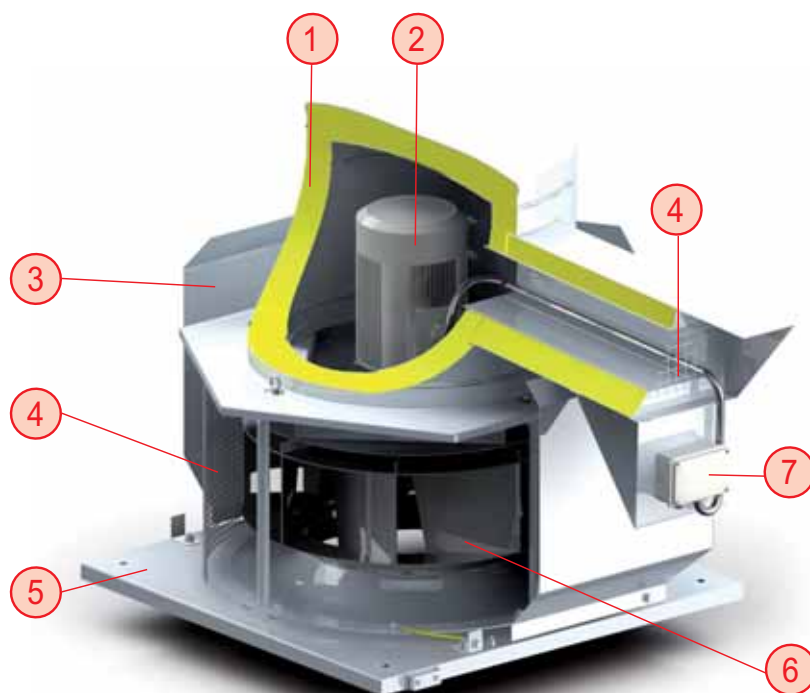

- 1 – Copertura termo-isolata
Insulated cover
- 2 – Motore/Motore
- 3 – Convogliatore
Conveyer
- 4 – Rete di protezione
Protection grid
- 5 – Base / Base
- 6 – Girante / Impeller
- 7 – Morsettiera esterna
External terminal box